



# GIR8-3-0163

Giraffe cart with Display mount, Computer holder, Work surface, Drawers and Transformer holder

## Giraffe 8 Range



*Ergonomic*



*Easy to clean*



*Multi purpose*



*Lifetime warranty*



*Quick setup*



## FEATURES



*Designed and manufactured in Hungary, products are typically 100% recyclable and upgradable in the future. Raw materials are sourced locally or in the EU.*

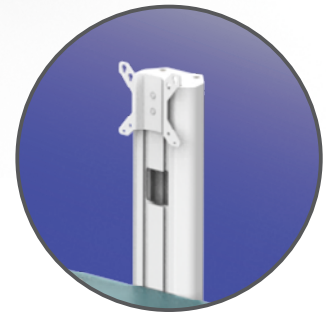

*Display mount and Cable management holes*

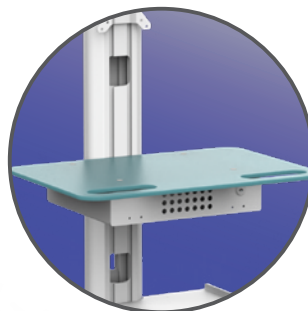

*Work surface with lockable computer holder*

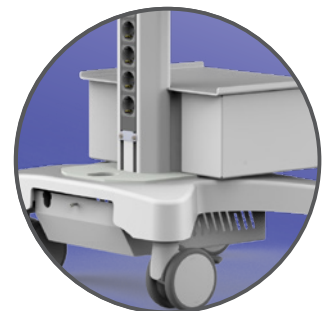

*Power strip and Transformer holder at the bottom*

# Cart Properties

## Dimensions and mechanical data

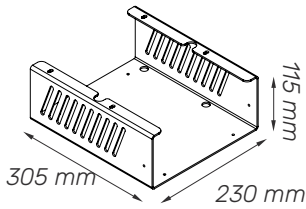

Transformer holder

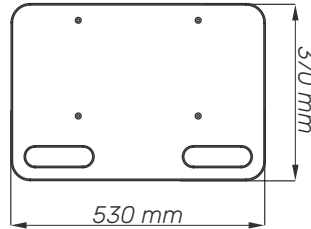

Work surface

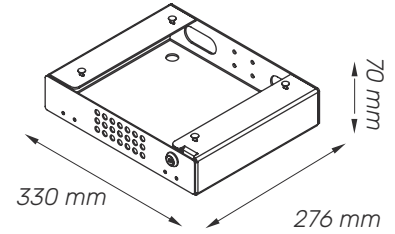

Computer holder

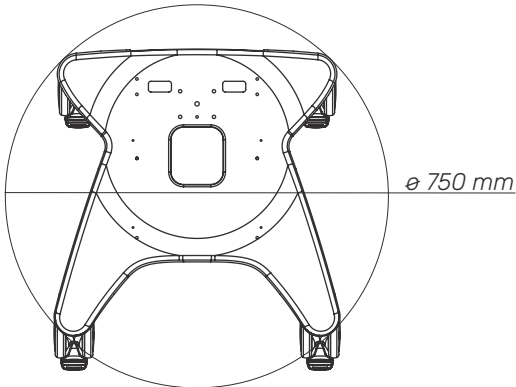

Base

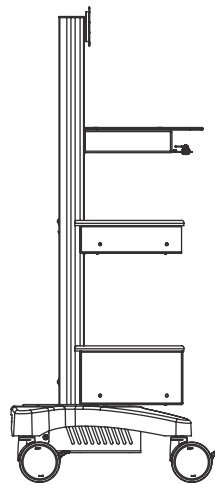

Front

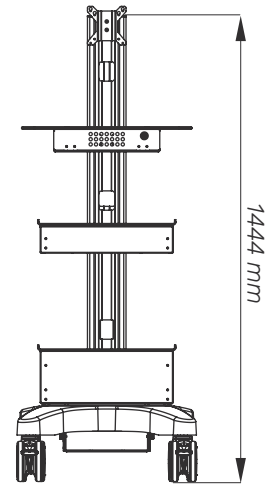

Side



### Mechanical data

Height	1444 mm
Wheelbase dimension	746 mm (diameter)
Wheel construction	Polyamide with Polyurethane tread
Wheels/locking	2 lockable, 100 mm diameter
Loading capacity	80 kg
Power strip	8 plugs

### Construction

Main material	Aluminium
---------------	-----------

### Color

RAL 9016	
Custom color	

### Certificates

Certificates conforms to	IEC60601-1:2012 (Edition 3)
CE	Rohs compliant